

# 8.1-8.4 Perimeter and Area Review ws

Find the perimeter AND area of the figures below.

1.

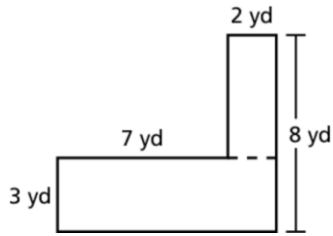

2.

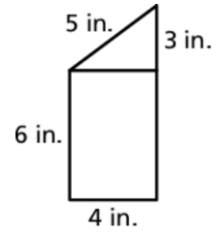

3.

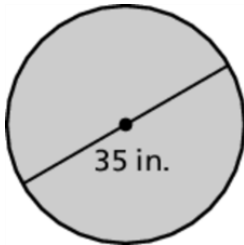

4.

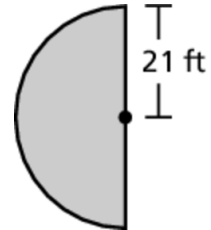

5.

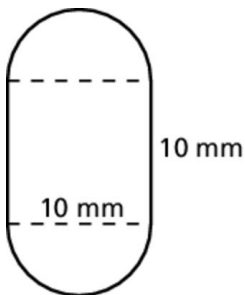

6.

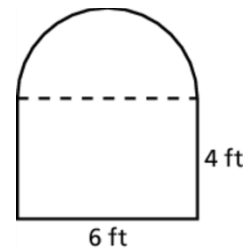

5. A stained glass window has the dimensions shown. What is the perimeter of the hole that should be cut in the wall in order for the window to be installed?

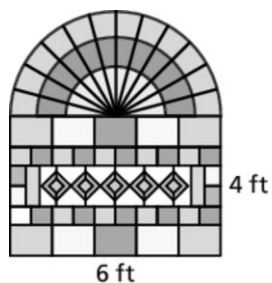

What is the area of the window to be installed?

6. The dimensions of a new city park basketball court are shown at the right. A fence is to be built around the court and bleachers. The fence costs \$8.99 per foot. How much will it cost to install the fence?

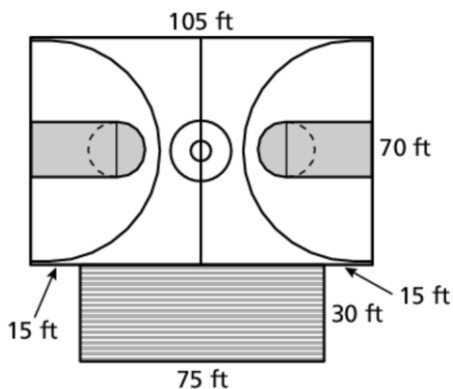

What is the area of the court and bleachers?