

Name: _____

Date: _____

Hour: _____

Area Review (pg 344)

Find the area of each figure.

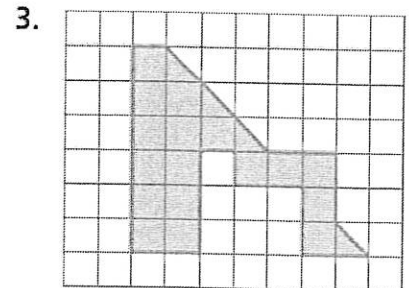
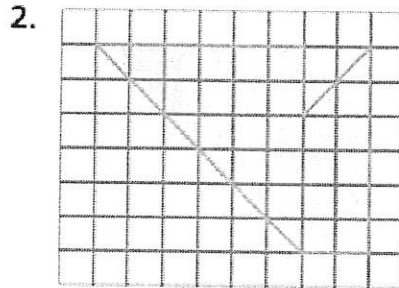
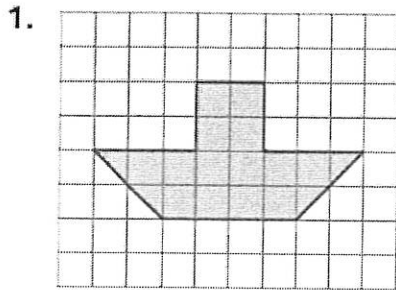

Find the area of the circles.

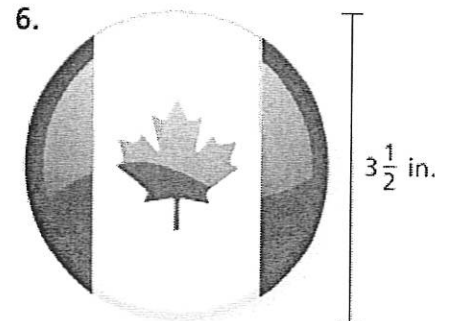
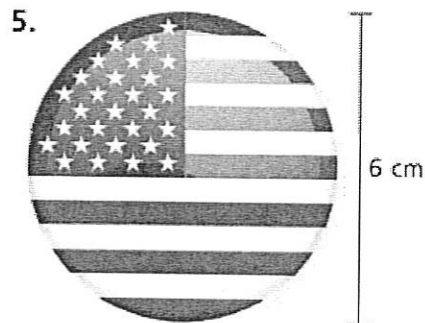
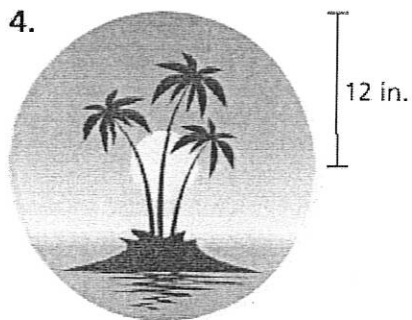

Find the area of each composite figure.

7.

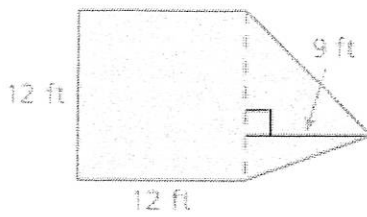

8.

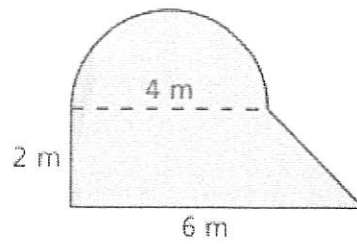

9.

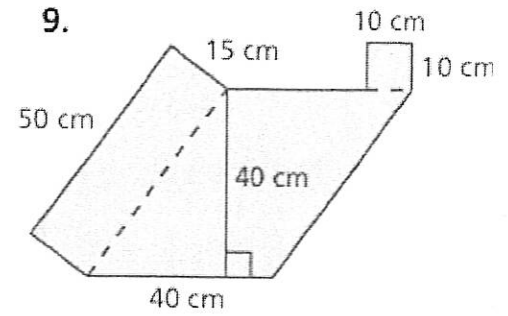

10. The heart-shaped card is made up of a square and two semicircles. Find the area.



11. The circular rug is placed on a square floor. The rug touches all four walls. How much of the floor space is not covered by the rug?

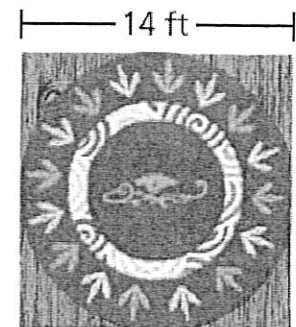

12. A desk is shaped like a semicircle with a diameter of 28 inches. What is the area?