

Name:

Date:

Hour:

Surface Area Review

Find the surface area of each solid.

1.

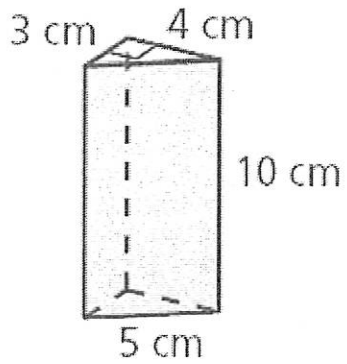

2.

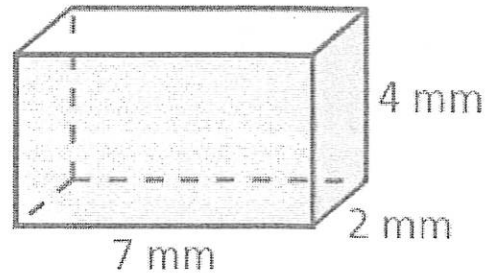

3.

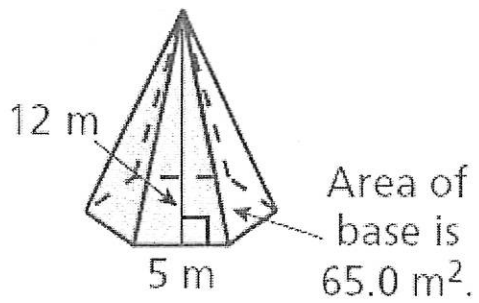

4.

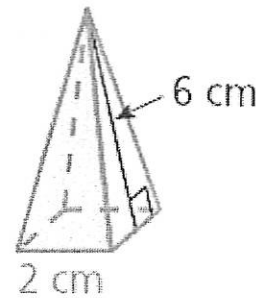

Find the surface area of each solid.

5.

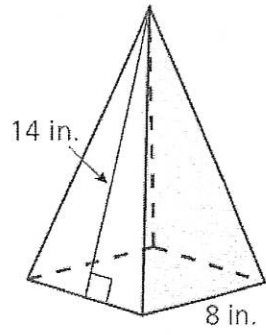

6.

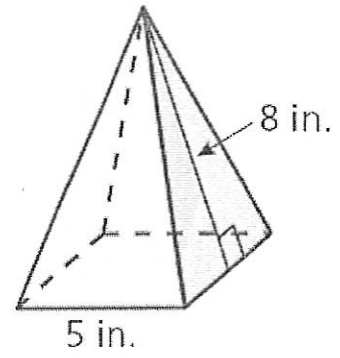

7.

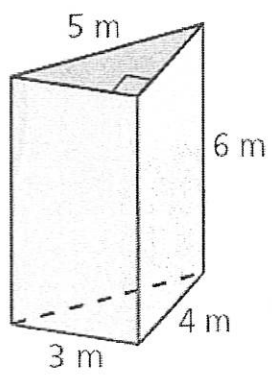

8.

